



SOT-89 Bipolar Transistor 双极型三极管

■ Features 特点

PNP High Voltage Switching 高压开关
Low Equivalent On-Resistance 低等效电阻

- 1. BASE
- 2. COLLECTOR
- 3. EMITTER

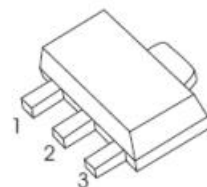

■ Absolute Maximum Ratings 最大额定值

Characteristic 特性参数	Symbol 符号	Rat 额定值	Unit 单位
Collector-Base Voltage 集电极基极电压	V_{CBO}	-120	V
Collector-Emitter Voltage 集电极发射极电压	V_{CEO}	-100	V
Emitter-Base Voltage 发射极基极电压	V_{EBO}	-6	V
Collector Current 集电极电流	I_C	-2000	mA
Collector Current Pulse 集电极脉冲电流	I_{CP}	-3000	mA
Power dissipation 耗散功率	$P_C(T_a=25^\circ C)$	500	mW
Thermal Resistance Junction-Ambient 热阻	$R_{\theta JA}$	250	$^\circ C/W$
Junction and Storage Temperature 结温和储藏温度	T_J, T_{stg}	-55to+150 $^\circ C$	

■ Device Marking 产品打标

H_{FE}	100-200	140-280	200-400
Mark	ACR	ACS	ACT



■ Electrical Characteristics 电特性

($T_A=25^{\circ}\text{C}$ unless otherwise noted 如无特殊说明, 温度为 25°C)

Characteristic 特性参数	Symbol 符号	Min 最小值	Type 典型值	Max 最大值	Unit 单位
Collector-Base Breakdown Voltage 集电极基极击穿电压($I_C = -100\mu\text{A}$, $I_E = 0$)	BV_{CBO}	-120	—	—	V
Collector-Emitter Breakdown Voltage 集电极发射极击穿电压($I_C = -1\text{mA}$, $I_B = 0$)	BV_{CEO}	-100	—	—	V
Emitter-Base Breakdown Voltage 发射极基极击穿电压($I_E = -100\mu\text{A}$, $I_C = 0$)	BV_{EBO}	-6	—	—	V
Collector-Base Leakage Current 集电极基极漏电流($V_{CB} = -100\text{V}$, $I_E = 0$)	I_{CBO}	—	—	-100	nA
Emitter-Base Leakage Current 发射极基极漏电流($V_{EB} = -4\text{V}$, $I_C = 0$)	I_{EBO}	—	—	-100	nA
DC Current Gain 直流电流增益($V_{CE} = -5\text{V}$, $I_C = -100\text{mA}$)	H_{FE}	100	—	400	
Collector-Emitter Saturation Voltage 集电极发射极饱和压降($I_C = -1000\text{mA}$, $I_B = -100\text{mA}$)	$V_{CE(sat)}$	—	-220	-600	mV
Base-Emitter Saturation Voltage 基极发射极饱和压降($I_C = -1000\text{mA}$, $I_B = -100\text{mA}$)	$V_{BE(sat)}$	—	-850	-1200	mV
Turn-on Time 开通时间 ($V_{CC} = -50\text{V}$, $I_C = -700\text{mA}$, $I_{B1} = -I_{B2} = -70\text{mA}$)	t_{on}	—	80	—	ns
Storage Time 贮存时间 ($V_{CC} = -50\text{V}$, $I_C = -700\text{mA}$, $I_{B1} = -I_{B2} = -70\text{mA}$)	t_s	—	750	—	ns
Fall Time 下降时间 ($V_{CC} = -50\text{V}$, $I_C = -700\text{mA}$, $I_{B1} = -I_{B2} = -70\text{mA}$)	t_f	—	40	—	ns
Transition Frequency 特征频率($V_{CE} = -10\text{V}$, $I_C = -100\text{mA}$)	f_T	—	120	—	MHz
Output Capacitance 输出电容($V_{CB} = -10\text{V}$, $I_E = 0$, $f = 1\text{MHz}$)	C_{ob}	—	25	—	pF

Typical Characteristic Curve 典型特性曲线

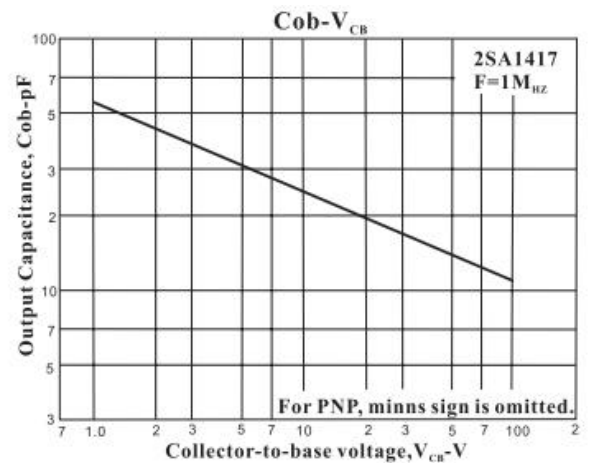
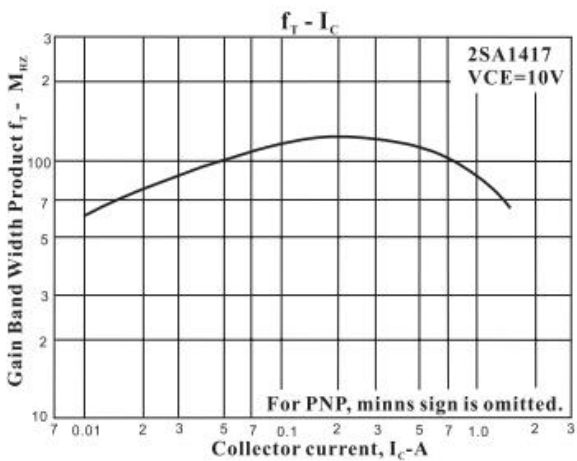
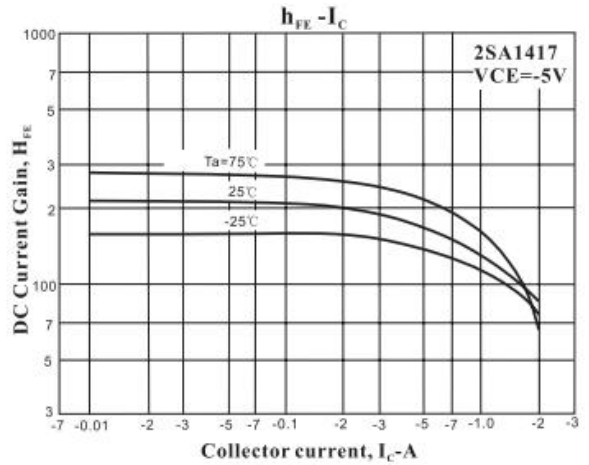
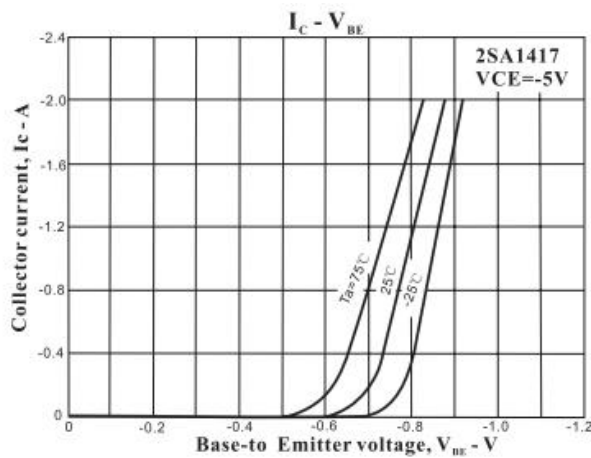
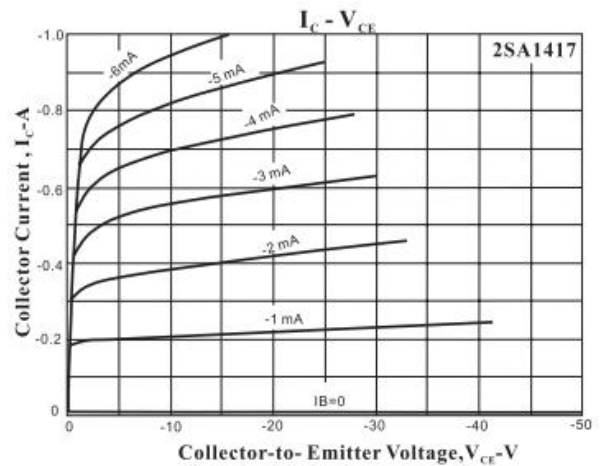
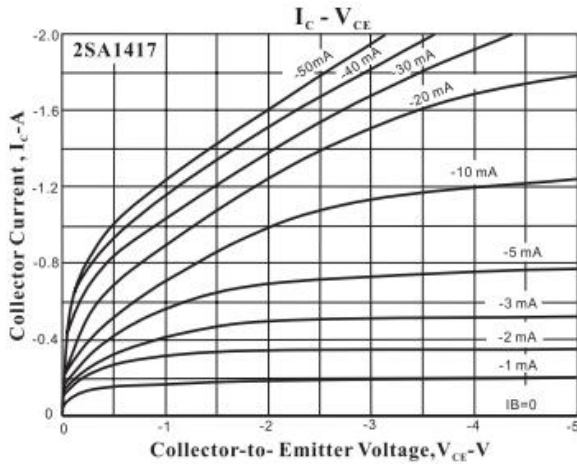

■ Typical Characteristic Curve 典型特性曲线

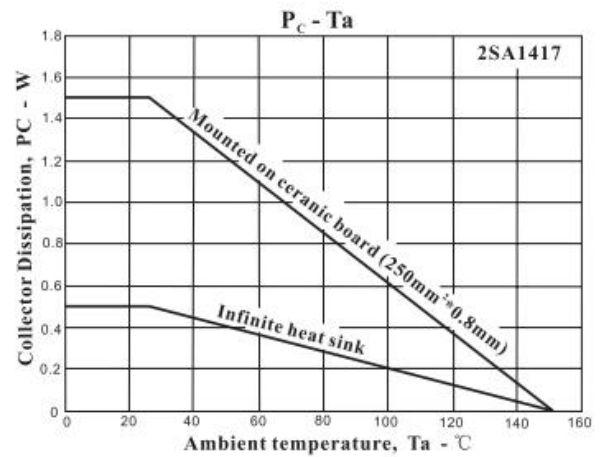
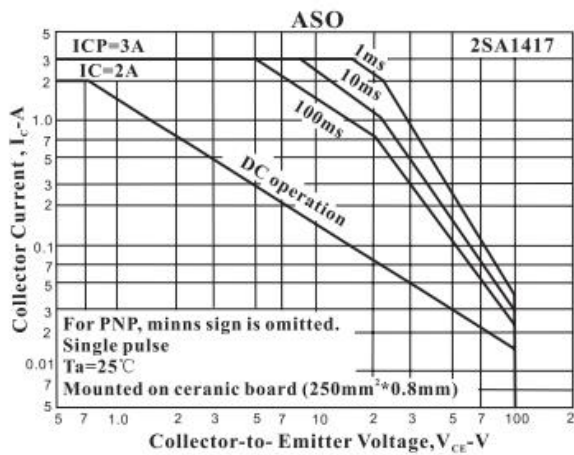
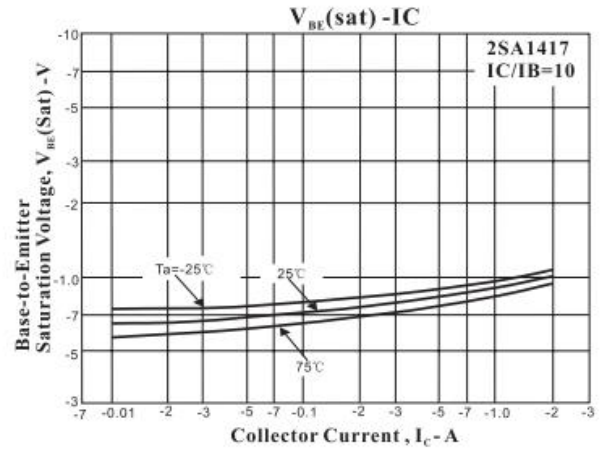
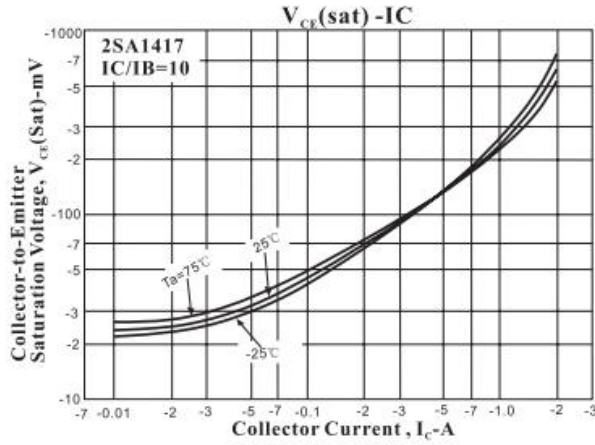

■ Test Circuit 测试电路

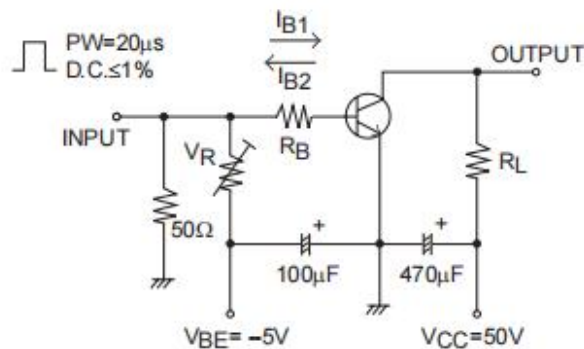

$10I_{B1} = -10I_{B2} = I_C = 0.7A$
For PNP, the polarity is reversed.

■Dimension 外形封装尺寸

