



安徽富信半导体科技有限公司

ANHUI FOSAN SEMICONDUCTOR TECHNOLOGY CO., LTD.

US1AL-US1ML

SOD-123FL Super Fast Recovery Diode 特快恢复二极管

■Features 特点

High current capability 高电流能力
 Low forward voltage drop 低正向压降
 Super Fast Recovery time 特快恢复时间
 Surface mount device 表面贴装器件
 Case 封装:SOD-123FL



■Maximum Rating 最大额定值

($T_A=25^{\circ}\text{C}$ unless otherwise noted 如无特殊说明, 温度为 25°C)

Characteristic 特性参数	Symbol 符号	US1AL	US1BL	US1DL	US1GL	US1JL	US1KL	US1ML	Unit 单位
Marking 印字		U1A	U1B	U1D	U1G	U1J	U1K	U1M	
Repetitive Peak Reverse Voltage 重复峰值反向电压	V_{RRM}	50	100	200	400	600	800	1000	V
DC Reverse Voltage 直流反向电压	V_R	50	100	200	400	600	800	1000	V
RMS Reverse Voltage 反向电压均方根值	$V_{R(RMS)}$	35	70	140	280	420	560	700	V
Forward Rectified Current 正向整流电流	I_F	1							A
Peak Surge Current 峰值浪涌电流	I_{FSM}	30							A
Thermal Resistance J-A 结到环境热阻	$R_{\theta JA}$	80							$^{\circ}\text{C}/\text{W}$
Junction/Storage Temperature 结温/储藏温度	T_J, T_{stg}	-50to+150 $^{\circ}\text{C}$							$^{\circ}\text{C}$

■Electrical Characteristics 电特性

($T_A=25^{\circ}\text{C}$ unless otherwise noted 如无特殊说明, 温度为 25°C)

Characteristic 特性参数	Symbol 符号	US1AL-US1DL	US1GL	US1JL-US1ML	Unit 单位	Condition 条件
Forward Voltage 正向电压	V_F	1.0	1.3	1.7	V	$I_F=1\text{A}$
Reverse Current 反向电流	I_R	5($T_A=25^{\circ}\text{C}$) 50($T_A=100^{\circ}\text{C}$)			μA	$V_R=V_{RRM}$
Reverse Recovery Time 反向恢复时间	T_{rr}	50		75	nS	$I_F=0.5\text{A}, I_R=1\text{A}$ $I_{rr}=0.25\text{A}$
Junction Capacitance 结电容	C_J	15			pF	$V_R=4\text{V}, f=1\text{MHz}$

■ Typical Characteristic Curve 典型特性曲线

FIG.1-TYPICAL FORWARD CHARACTERISTICS

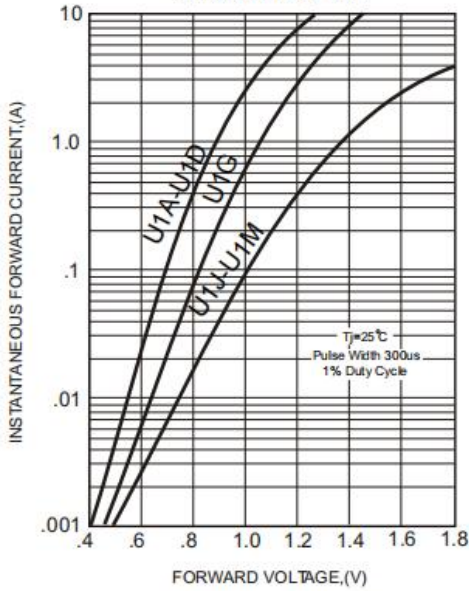

FIG.2-TYPICAL FORWARD CURRENT DERATING CURVE

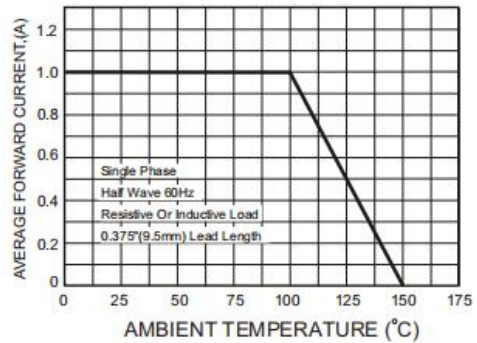
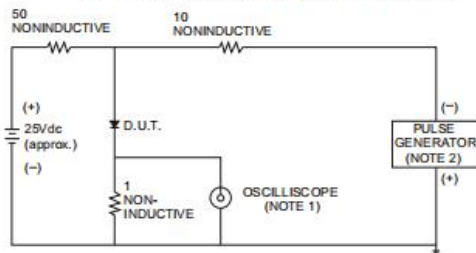

FIG.3- TEST CIRCUIT DIAGRAM AND REVERSE RECOVERY TIME CHARACTERISTICS



NOTES: 1. Rise Time = 7ns max., Input Impedance = 1 megohm, 22pF.
2. Rise Time = 10ns max., Source Impedance = 50 ohms.

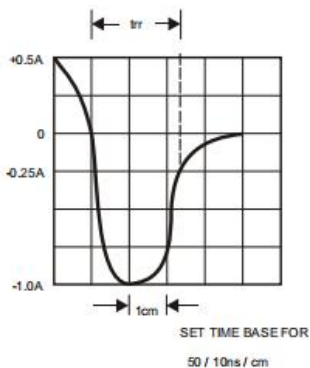

FIG.4-MAXIMUM NON-REPETITIVE FORWARD SURGE CURRENT

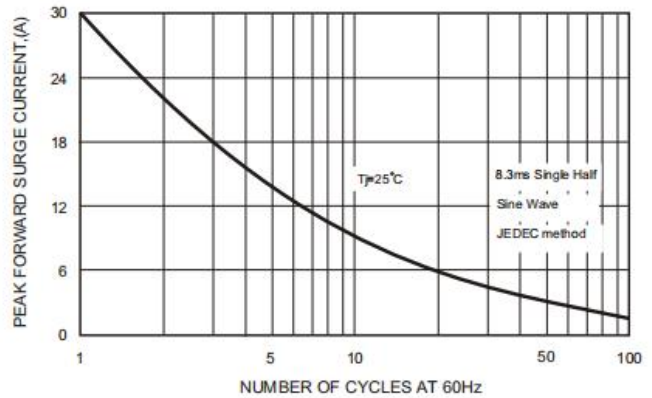
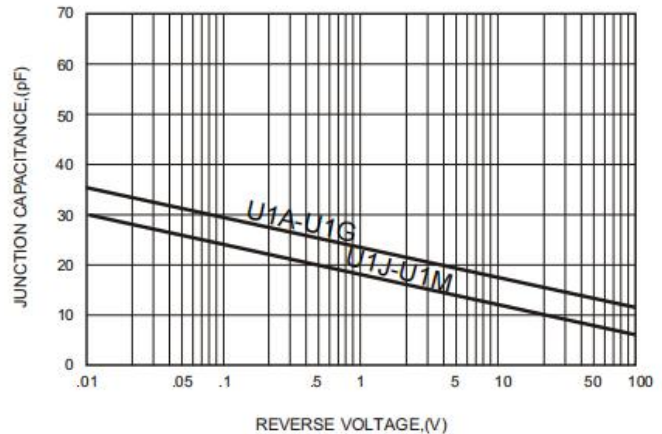
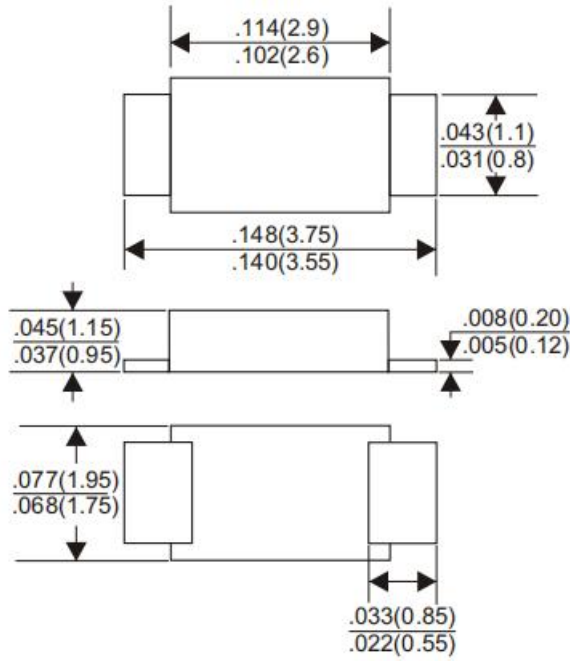

FIG.5-TYPICAL JUNCTION CAPACITANCE





■Dimension 外形封装尺寸



Dimensions in inches and (millimeters)