



## TO-252 N Channel Enhancement 沟道增强型 MOS Field Effect Transistor 场效应管

### ■ Features 特点

Low on-resistance 低导通电阻  
 $R_{DS(ON)}=11m\Omega(\text{Type})@V_{GS}=10V$   
 $R_{DS(ON)}=13.5m\Omega(\text{Type})@V_{GS}=4.5V$

### ■ Applications 应用

Motor Drive 马达驱动  
DC-DC Conversion 升压转换  
Power Management 电源管理

### ■ Internal Schematic Diagram 内部结构

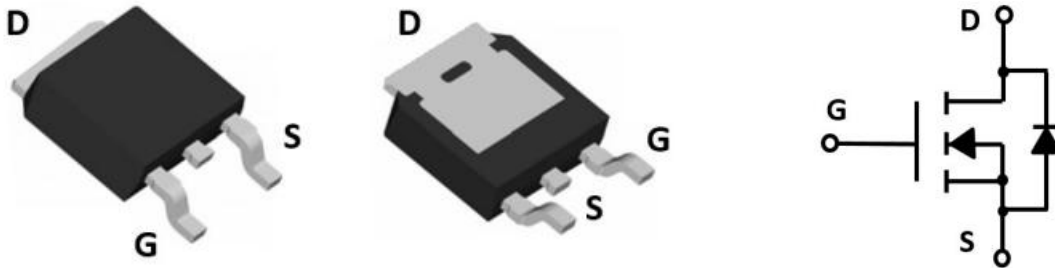

### ■ Absolute Maximum Ratings 最大额定值

Characteristic 特性参数	Symbol 符号	Rat 额定值	Unit 单位
Drain-Source Voltage 漏极-源极电压	$BV_{DSS}$	60	V
Gate- Source Voltage 栅极-源极电压	$V_{GS}$	$\pm 20$	V
Drain Current (continuous)漏极电流-连续	$I_D$ (at $T_A = 25^\circ C$ at $T_A = 100^\circ C$ )	50 42	A
Drain Current (pulsed)漏极电流-脉冲	$I_{DM}$	200	A
Total Device Dissipation 总耗散功率	$P_{TOT}$ (at $T_A = 25^\circ C$ at $T_A = 100^\circ C$ )	54 21.6	W
Thermal Resistance Junction-Case 热阻	$R_{\theta JC}$	2.3	$^\circ C/W$
Thermal Resistance Junction-Ambient 热阻	$R_{\theta JA}$	20	$^\circ C/W$
Avalanche Energy Single Pulse 雪崩能量	$E_{AS}$	49	mJ
Junction/Storage Temperature 结温/储存温度	$T_J, T_{stg}$	-55~150	$^\circ C$



## ■ Electrical Characteristics 电特性

( $T_A=25^{\circ}\text{C}$  unless otherwise noted 如无特殊说明, 温度为  $25^{\circ}\text{C}$ )

Characteristic 特性参数	Symbol 符号	Min 最小值	Typ 典型值	Max 最大值	Unit 单位
Drain-Source Breakdown Voltage 漏极-源极击穿电压( $I_D=250\mu\text{A}, V_{GS}=0\text{V}$ )	$BV_{DSS}$	60	—	—	V
Gate Threshold Voltage 栅极开启电压( $I_D=250\mu\text{A}, V_{GS}=V_{DS}$ )	$V_{GS(th)}$	1.0	1.5	2.5	V
Zero Gate Voltage Drain Current 零栅压漏极电流( $V_{GS}=0\text{V}, V_{DS}=48\text{V}$ )	$I_{DSS}$	—	—	1	$\mu\text{A}$
Gate Body Leakage 栅极漏电流( $V_{GS}=\pm 20\text{V}, V_{DS}=0\text{V}$ )	$I_{GSS}$	—	—	$\pm 100$	nA
Static Drain-Source On-State Resistance 静态漏源导通电阻( $I_D=15\text{A}, V_{GS}=10\text{V}$ ) ( $I_D=10\text{A}, V_{GS}=4.5\text{V}$ )	$R_{DS(ON)}$	—	11 13.5	15 17	$\text{m}\Omega$
Diode Forward Voltage Drop 内附二极管正向压降( $I_{SD}=15\text{A}, V_{GS}=0\text{V}$ )	$V_{SD}$	—	0.8	1.2	V
Input Capacitance 输入电容 ( $V_{GS}=0\text{V}, V_{DS}=30\text{V}, f=1\text{MHz}$ )	$C_{ISS}$	—	2585	—	pF
Common Source Output Capacitance 共源输出电容( $V_{GS}=0\text{V}, V_{DS}=30\text{V}, f=1\text{MHz}$ )	$C_{OSS}$	—	150	—	pF
Reverse Transfer Capacitance 反馈电容( $V_{GS}=0\text{V}, V_{DS}=30\text{V}, f=1\text{MHz}$ )	$C_{RSS}$	—	78	—	pF
Total Gate Charge 栅极电荷密度 ( $V_{DS}=30\text{V}, I_D=20\text{A}, V_{GS}=10\text{V}$ )	$Q_g$	—	51	—	nC
Gate Source Charge 栅源电荷密度 ( $V_{DS}=30\text{V}, I_D=20\text{A}, V_{GS}=10\text{V}$ )	$Q_{gs}$	—	10	—	nC
Gate Drain Charge 栅漏电荷密度 ( $V_{DS}=30\text{V}, I_D=20\text{A}, V_{GS}=10\text{V}$ )	$Q_{gd}$	—	10	—	nC
Turn-ON Delay Time 开启延迟时间 ( $V_{DS}=30\text{V}, I_D=20\text{A}, R_{GEN}=3\Omega, V_{GS}=10\text{V}$ )	$t_{d(on)}$	—	11	—	ns
Turn-ON Rise Time 开启上升时间 ( $V_{DS}=30\text{V}, I_D=20\text{A}, R_{GEN}=3\Omega, V_{GS}=10\text{V}$ )	$t_r$	—	25	—	ns
Turn-OFF Delay Time 关断延迟时间 ( $V_{DS}=30\text{V}, I_D=20\text{A}, R_{GEN}=3\Omega, V_{GS}=10\text{V}$ )	$t_{d(off)}$	—	89	—	ns
Turn-OFF Fall Time 关断下降时间 ( $V_{DS}=30\text{V}, I_D=20\text{A}, R_{GEN}=3\Omega, V_{GS}=10\text{V}$ )	$t_f$	—	79	—	ns

## ■ Typical Characteristic Curve 典型特性曲线

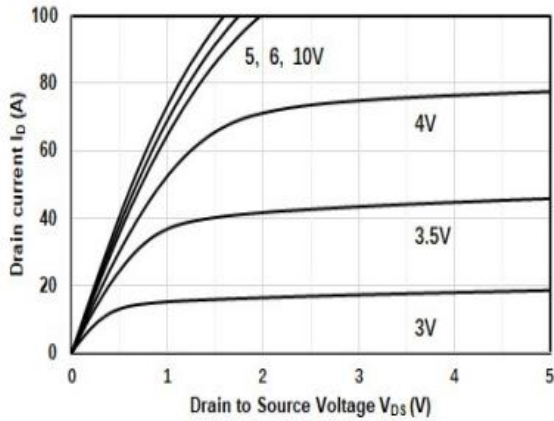

Figure 1: Output Characteristics

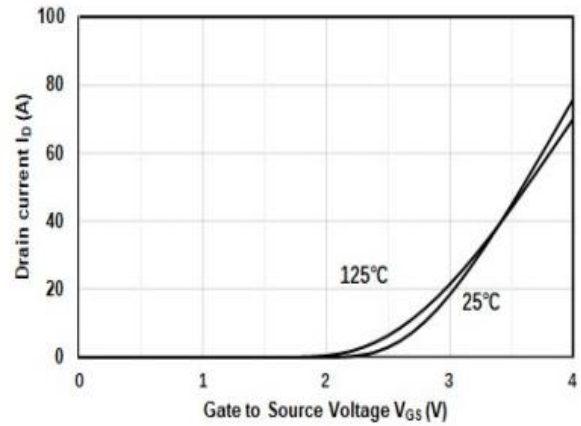

Figure 2: Transfer Characteristics

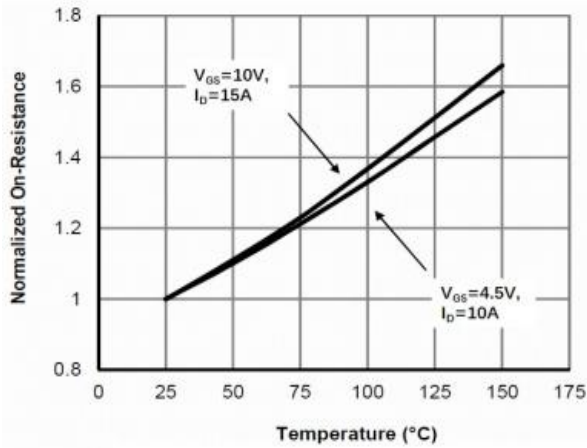

Figure 3: On-Resistance vs.  $T_J$

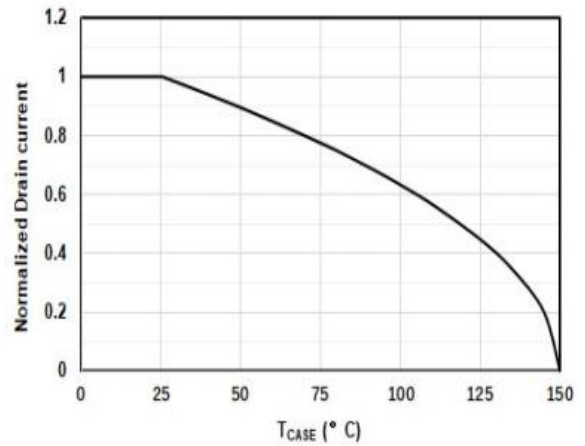

Figure 4: Drain Current vs. Temperature

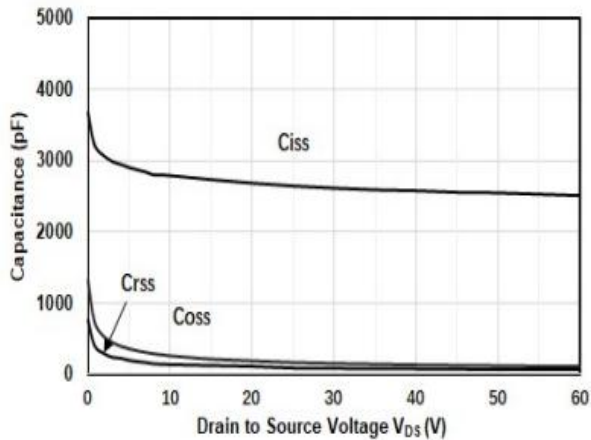

Figure 5: Capacitance Characteristics

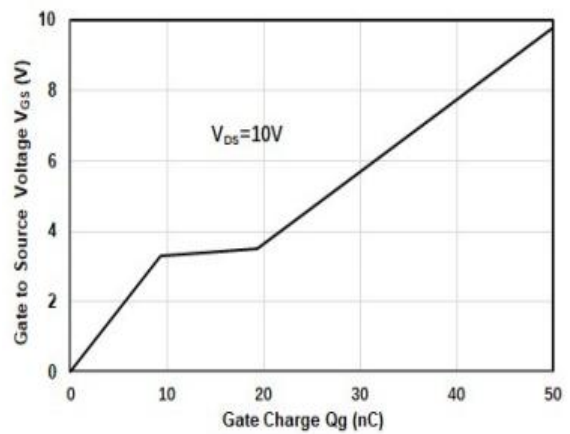

Figure 6: Gate-Charge Characteristics

## ■ Typical Characteristic Curve 典型特性曲线

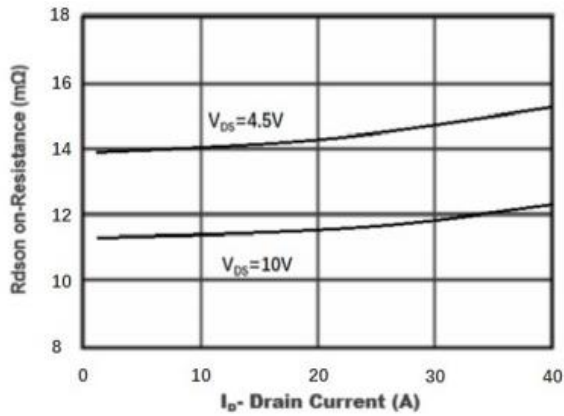

Figure 7: On-Resistance vs. Drain Current

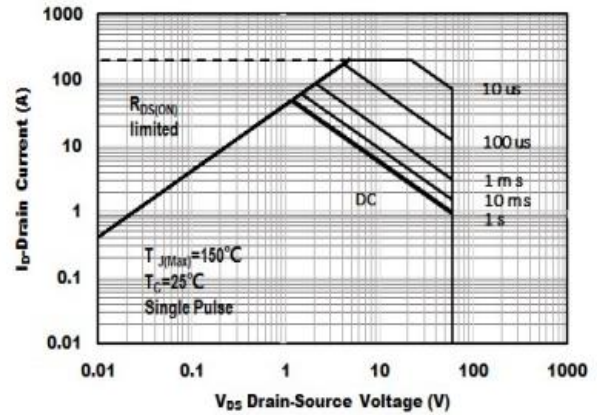

Figure 8: Safe Operating Area

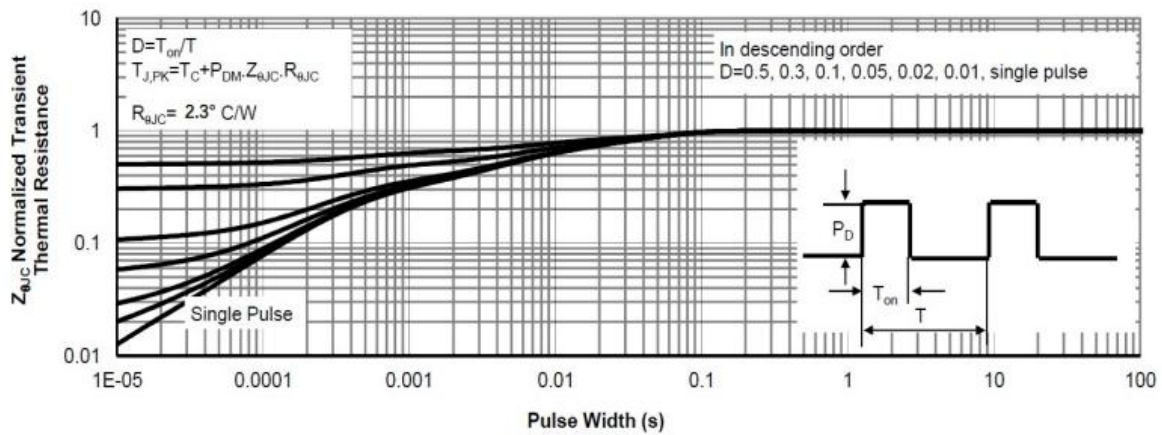
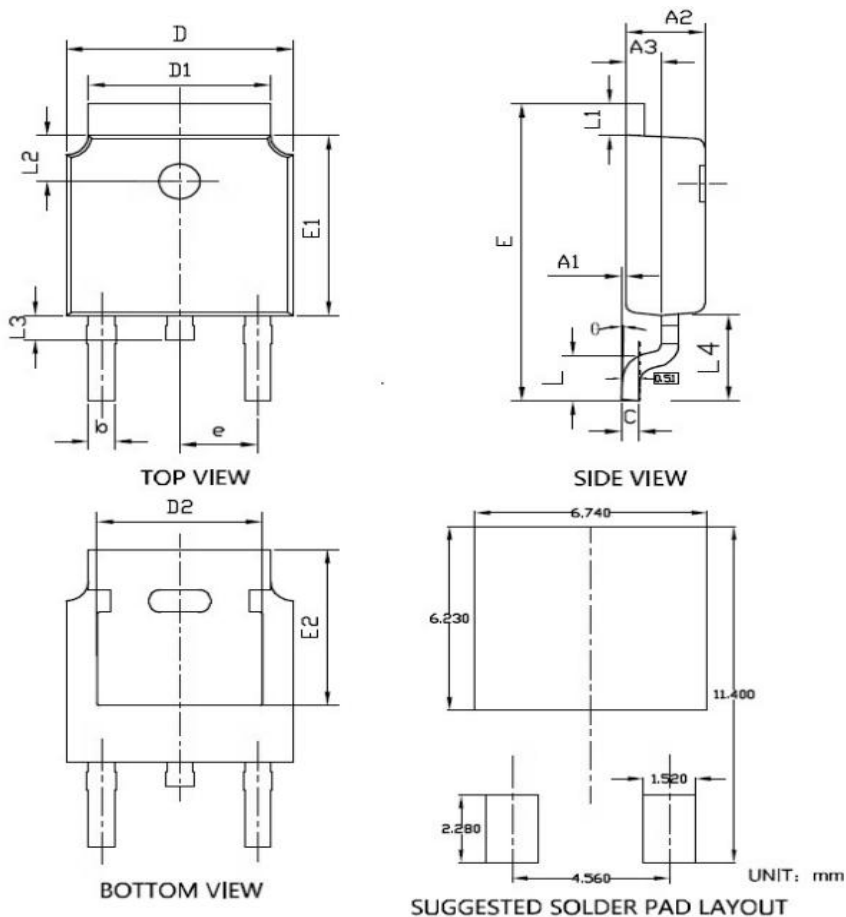

Figure 9: Transient Thermal Response Curve

## Dimension 外形封装尺寸



DIMENSIONS						
SYMBOL	INCHES			Millimeter		
	MIN.	NOM.	MAX.	MIN.	NOM.	MAX.
A1	0.000	---	0.008	0.000	---	0.200
A2	0.087	0.091	0.094	2.200	2.300	2.400
A3	0.035	0.039	0.043	0.900	1.000	1.100
b	0.026	0.030	0.034	0.660	0.760	0.860
c	0.018	0.020	0.023	0.460	0.520	0.580
D	0.256	0.260	0.264	6.500	6.600	6.700
D1	0.203	0.209	0.215	5.150	5.300	5.450
D2	0.181	0.189	0.195	4.600	4.800	4.950
E	0.390	0.398	0.406	9.900	10.100	10.300
E1	0.236	0.240	0.244	6.000	6.100	6.200
E2	0.203	0.209	0.215	5.150	5.300	5.450
e	0.090BSC			2.286BSC		
L	0.049	0.059	0.069	1.250	1.500	1.750
L1	0.035	---	0.050	0.900	---	1.270
L2	0.055	---	0.075	1.400	---	1.900
L3	0.240	0.310	0.039	0.600	0.800	1.000
L4	0.114REF			2.900REF		
0	0°	---	10°	0°	---	10°