



安徽富信半导体科技有限公司

ANHUI FOSAN SEMICONDUCTOR TECHNOLOGY CO., LTD.

RS2A-RS2M

SMA Fast Recovery Diode 快恢复二极管

■Features 特点

Glass Passivated Chip Junction 玻璃钝化芯片结

Fast Recovery time 快恢复时间

Surface mount device 表面贴装器件

Case 封装:SMA

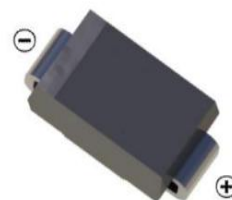

■Maximum Rating 最大额定值

($T_A=25^{\circ}\text{C}$ unless otherwise noted 如无特殊说明, 温度为 25°C)

Characteristic 特性参数	Symbol 符号	RS 2A	RS 2B	RS 2D	RS 2G	RS 2J	RS 2K	RS 2M	Unit 单位
Repetitive Peak Reverse Voltage 重复峰值反向电压	V_{RRM}	50	100	200	400	600	800	1000	V
DC Reverse Voltage 直流反向电压	V_R	50	100	200	400	600	800	1000	V
RMS Reverse Voltage 反向电压均方根值	$V_{R(RMS)}$	35	70	140	280	420	560	700	V
Forward Rectified Current 正向整流电流	I_F	2							A
Peak Surge Current 峰值浪涌电流	I_{FSM}	50							A
Thermal Resistance J-A 结到环境热阻	$R_{\theta JA}$	65							$^{\circ}\text{C}/\text{W}$
Operating and Storage Temperature Range 工作温度和储藏温度范围	T_J, T_{stg}	-65to+150 $^{\circ}\text{C}$							$^{\circ}\text{C}$

■Electrical Characteristics 电特性

($T_A=25^{\circ}\text{C}$ unless otherwise noted 如无特殊说明, 温度为 25°C)

Characteristic 特性参数	Symbol 符号	RS2A-RS2G	RS2J	RS2K-RS2M	Unit 单位	Condition 条件
Forward Voltage 正向电压	V_F	1.3			V	$I_F=2\text{A}$
Reverse Current 反向电流	I_R	5($T_A=25^{\circ}\text{C}$) 300($T_A=125^{\circ}\text{C}$)			μA	$V_R=V_{RRM}$
Reverse Recovery Time 反向恢复时间	T_{rr}	150	250	500	nS	$I_F=0.5\text{A}, I_R=1\text{A}$ $I_{rr}=0.25\text{A}$
Junction Capacitance 结电容	C_J	50			pF	$V_R=4\text{V}, f=1\text{MHz}$

■ Typical Characteristic Curve 典型特性曲线

FIG.1-TYPICAL FORWARD CHARACTERISTICS

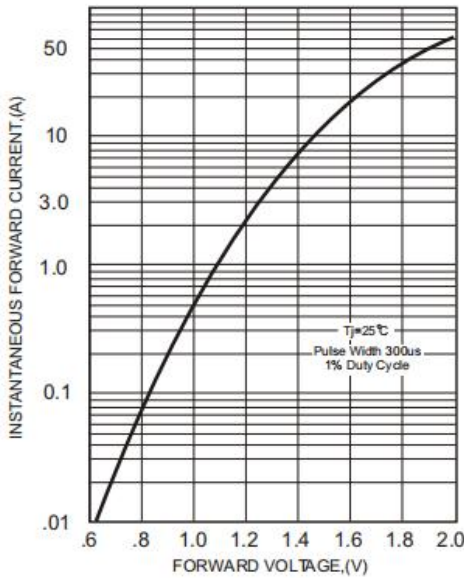

FIG.2-TYPICAL FORWARD CURRENT DERATING CURVE

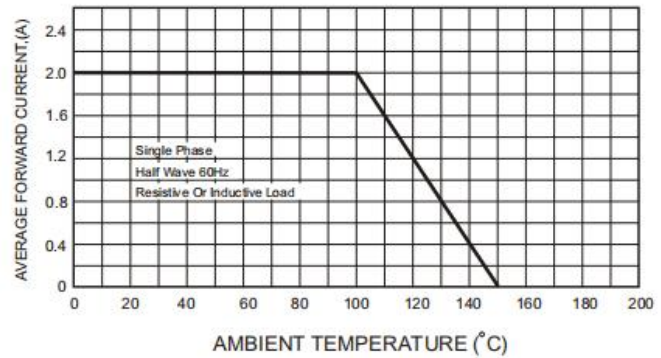

FIG.4-MAXIMUM NON-REPETITIVE FORWARD SURGE CURRENT

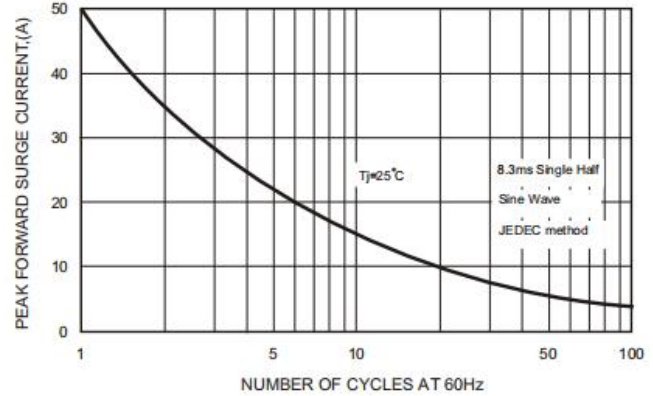
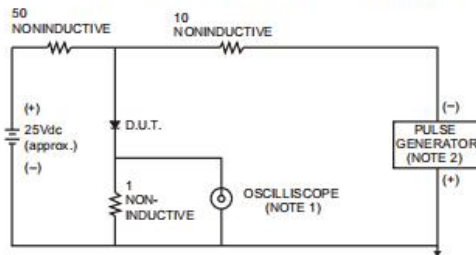

FIG.3- TEST CIRCUIT DIAGRAM AND REVERSE RECOVERY TIME CHARACTERISTICS



NOTES: 1. Rise Time= 7ns max., Input Impedance= 1 megohm, 22pF.

2. Rise Time= 10ns max., Source Impedance= 50 ohms.

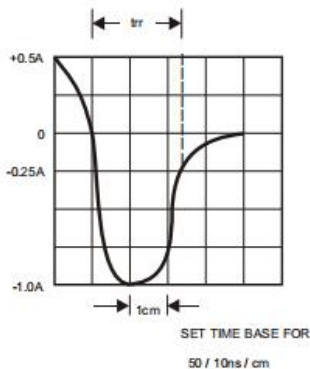
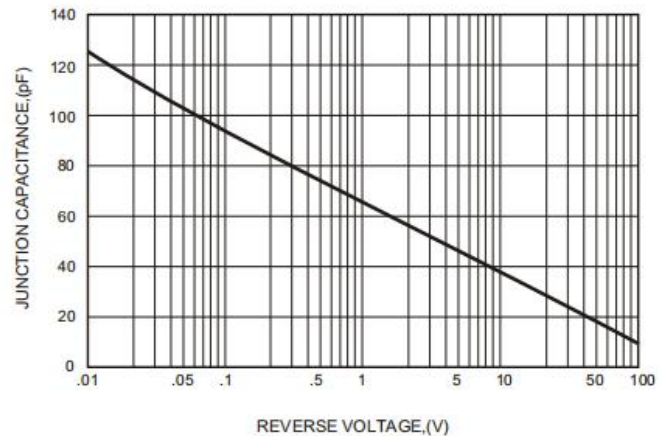
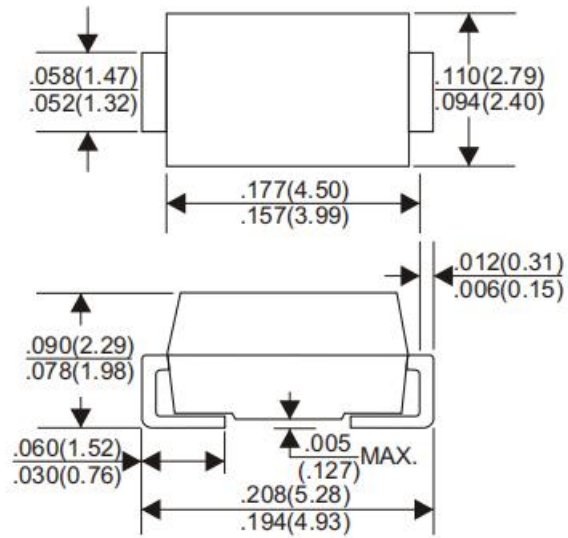

FIG.5-TYPICAL JUNCTION CAPACITANCE



■Dimension 外形封装尺寸

DO-214AC(SMA)



Dimensions in inches and (millimeters)