



安徽富信半导体科技有限公司

ANHUI FOSAN SEMICONDUCTOR TECHNOLOGY CO., LTD.

ES3A-ES3J

SMB Super Fast Recovery Diode 超快恢复二极管

■ Features 特点

Built-in Strain Relief 内应力释放
 Fast Switching Speed 快的开关速度
 Super Fast Recovery time 超快恢复时间
 Surface Mount Device 表面贴装器件
 Case 封装:SMB(DO214-AA)



■ Maximum Rating 最大额定值

($T_A=25^{\circ}\text{C}$ unless otherwise noted 如无特殊说明, 温度为 25°C)

Characteristic 特性参数	Symbol 符号	ES 3A	ES 3B	ES 3C	ES 3D	ES 3E	ES 3G	ES 3J	Unit 单位
Repetitive Peak Reverse Voltage 重复峰值反向电压	V_{RRM}	50	100	150	200	300	400	600	V
DC Reverse Voltage 直流反向电压	V_R	50	100	150	200	300	400	600	V
RMS Reverse Voltage 反向电压均方根值	$V_{R(RMS)}$	35	70	105	140	210	280	420	V
Forward Rectified Current 正向整流电流	I_F	3							A
Peak Surge Current 峰值浪涌电流	I_{FSM}	80							A
Thermal Resistance J-A 结到环境热阻	$R_{\theta JA}$	40							$^{\circ}\text{C}/\text{W}$
Operating and Storage Temperature Range 工作温度和储藏温度范围	T_I, T_{stg}	-65to+150 $^{\circ}\text{C}$							$^{\circ}\text{C}$

■ Electrical Characteristics 电特性

($T_A=25^{\circ}\text{C}$ unless otherwise noted 如无特殊说明, 温度为 25°C)

Characteristic 特性参数	Symbol 符号	ES3A-ES3D	ES3E-ES3G	ES3J	Unit 单位	Condition 条件
Forward Voltage 正向电压	V_F	1	1.4	1.7	V	$I_F=3\text{A}$
Reverse Current 反向电流	I_R	5($T_A=25^{\circ}\text{C}$) 50($T_A=100^{\circ}\text{C}$)			μA	$V_R=V_{RRM}$
Reverse Recovery Time 反向恢复时间	T_{rr}	35			nS	$I_F=0.5\text{A}, I_R=1\text{A}$ $I_{rr}=0.25\text{A}$
Junction Capacitance 结电容	C_J	60			pF	$V_R=4\text{V}, f=1\text{MHz}$

■ Typical Characteristic Curve 典型特性曲线

FIG.1- TEST CIRCUIT DIAGRAM AND REVERSE RECOVERY TIME CHARACTERISTIC

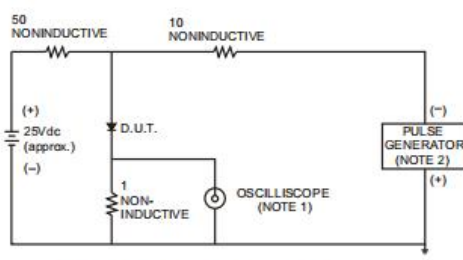

NOTES: 1. Rise Time= 7ns max., Input Impedance= 1 megohm, 22pF.
2. Rise Time= 10ns max., Source Impedance= 50 ohms.

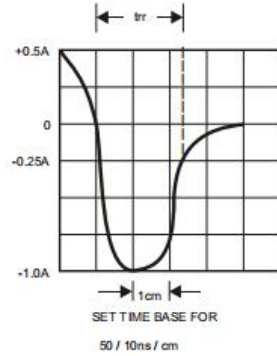

FIG.2-TYPICAL FORWARD CURRENT DERATING CURVE

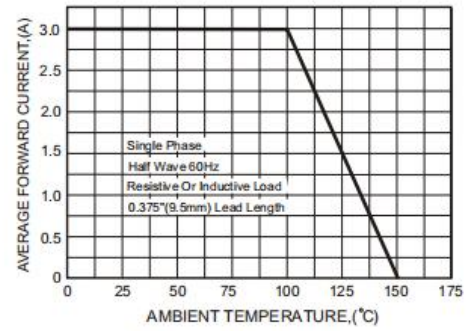

FIG.3-TYPICAL FORWARD CHARACTERISTICS

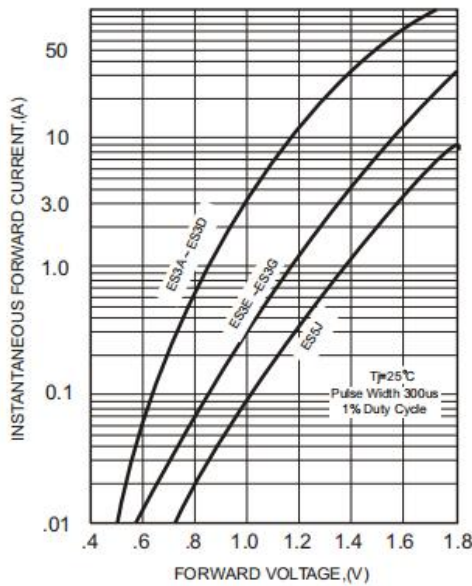

FIG.4-TYPICAL REVERSE CHARACTERISTICS

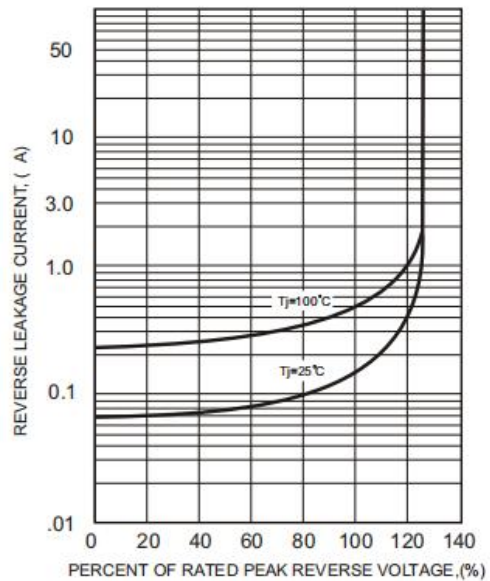

FIG.5-MAXIMUM NON-REPETITIVE FORWARD SURGE CURRENT

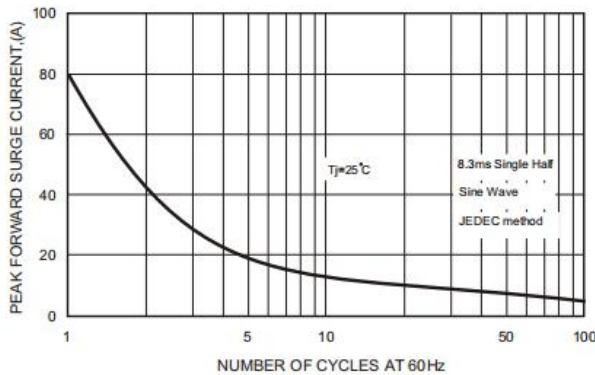
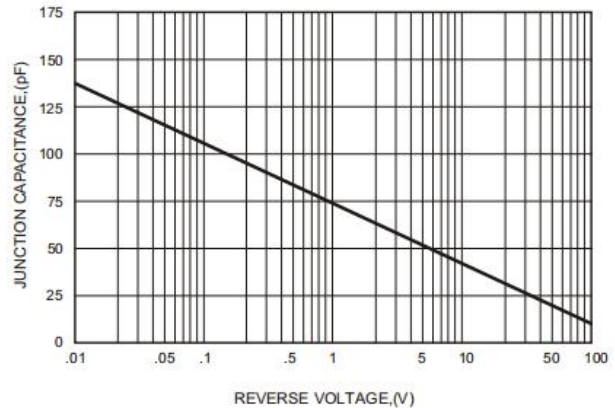
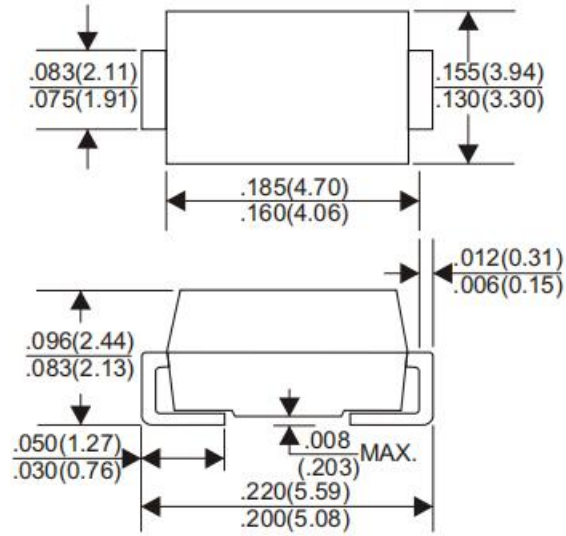

FIG.6-TYPICAL JUNCTION CAPACITANCE



■Dimension 外形封装尺寸

DO-214AA(SMB)



Dimensions in inches and (millimeters)